



SOFC UTILITY INTERFACE – A COMPARATIVE WITH BATTERY ENERGY SYSTEM

Anuradha S Deshpande

Associate Professor, Department of Electrical Engineering, Faculty of Technology & Engineering, Maharaja Sayajirao
University of Baroda, Vadodara-390001, Gujarat, India

ABSTRACT: Modern technology practices green technology concept in respect of power generation and supply. Importance of utilization of non-conventional methods of generation & battery (Fuel Cell) as power plant are need of the hour. Paper has made an attempt for utility & SOFC integration using DC/AC conversion technology. Use of solid oxide fuel cell is demonstrated for supplying utility modeled as Infinite Bus through DC/AC conversion. Mat lab simulation for SOFC & utility interface was done to establish parameters of SOFC and Infinite bus with respect to dc voltage & current, Active & reactive power of fuel cell & infinite bus, terminal voltage of fuel cell & Infinite bus, three phase voltage of FC & IB and three phase current of IB. Simulation results suggest $1pu V_t$ at FC & IB & adequate power at utility. A comparative with SOFC replacing battery was also done. Batteries resembling power plant size were integrated with IB as utility. Mat lab simulation results were identical and at times better (V_t , V_{abc} , I_{abc}), in direct comparison with SOFC. Thus proposed work has successfully established utility interface with SOFC & batteries for isolated consumers or isolated installations. Application of SOFC and utility interface can be utilized as distributed generation source in a micro grid for isolated operation during islanding.

Key Words: Solid oxide fuel cell (SOFC), Battery, Utility, Inverter, Infinite Bus.

1. INTRODUCTION

Sustainable development and green technologies are making clean atmosphere concept due to zero emission levels. Modern world stresses use of pollution free sources of generation (Non Conventional Sources like Wind, solar etc). Research in the area of power generation through fuel cells and battery power plant has increased many times. Concept of distributed generation has also percolated up to bottom of the smallest power system. Micro grid operation during islanding condition has provided option of emergency operation, of the power system together with normal operation of the power system.

Solid oxide fuel cell technology is a concept which is gaining wide importance due to its application as Generating power plant or as stationary power station. The solid oxide fuel cell technology employs a variety of oxide ion conducting ceramic materials as the electrolytes. Zirconium is the most common and widely accepted electrolyte material for the high temperature SOFC. Due to high operating temperature, SOFC bears the advantage of faster reaction kinetics, fuel flexibility and does not require expensive catalyst like the low temperature fuel cells. It can consume CO as fuel but it does not require recycling of CO_2 from anode to cathode leading to further simplification of the system. High temperature operation and tolerance to impure fuel streams make SOFC especially attractive when combined with coal gasification plant. SOFC can be fabricated in to a variety of self supporting shapes and configurations that are not feasible with cells employing liquid electrolytes. Operating Temp $^{\circ}C$ – 500-1000, Fuel/Oxidant – Natural Gas, Bio gas, H_2/O_2 (Air), Realized Power – 100-250KW, Electrolytic charge carrier – O^{2-} , Application – Generator, Stationary Power Source.

World scenario about fuel cell market approach is to achieve durability of the system for 3000 hour to 5000 hour and to lower the cost below \$100/KW. Above concept can be materialized by integrating utility with SOFC. DC/AC converters or inverters are basically of VSI and CSI type. VSI uses a diode rectifier and a capacitive filter at the front



end and does not have inherent regenerative capability. Both sinusoidal PWM and hysteresis band current controlled methods are widely used to regulate the voltage magnitude and harmonic ripple at the output. Several methods of PWM control including the latest space vector modulation (SVM) technique and multi level inverters have been introduced with GTO's, IGBT's, IGCT's, or IGET's in a doubly sided (dual) PWM VSI fed rectifier inverter high power drive for bi directional power flow and sinusoidal current both at the input and the output together with unity supply power factor.

Research in the area of SOFC is revealing development in recent years. C. J. Hatziadoniu [3] suggest study suitable for planning studies, considering 2 major loops for voltage and power control with dynamic performance of the exciter utility and its sensitivity to some planning variables such as generation mix and controller rate of response are investigated. Fuel cell and gas turbine plants are considered in the study of distributed generation, for a utility. Padulles [5] has developed general characteristics of the model, plant structure applicable to SOFC technology, in terms of determination of safe operating area by V-I and P-I plots. Work has considered simulation aspects. Sedghisigarchi [6] developed dynamic response of SOFC for fast and slow perturbations, i.e., model is suitable for both small signal and transient stability studies. Simulation in power analysis tool box (PAT), a MAT LAB based tool box was done which shows that for very fast load variations, temperature and species dynamic can be ignored. Zhu [7] has modeling of micro turbine and SOFC system, in standalone mode. Evaluations of these standalone models show that they are reasonable and suitable for slow dynamic simulations. A distribution system with practical control strategies is developed for analysis of load following service provided by turbines and fuel cell.

Proposed work has made an attempt to project/establish SOFC suitability over battery system. Also application of SOFC for standalone application for micro grid in islanding condition and for distributed generation is proposed. Integration of SOFC with grid suggests standalone application. Literature survey has no standalone application development as DG or micro grid. Wave forms of battery and SOFC, establish suitability of SOFC which is not done in earlier work. No parameter comparison is done. Thus paper has contributed to the research in area of SOFC as a stationary power source.

II. MODELLING OF COMPONENTS

Fig 1 Block diagram representation of developed work is:

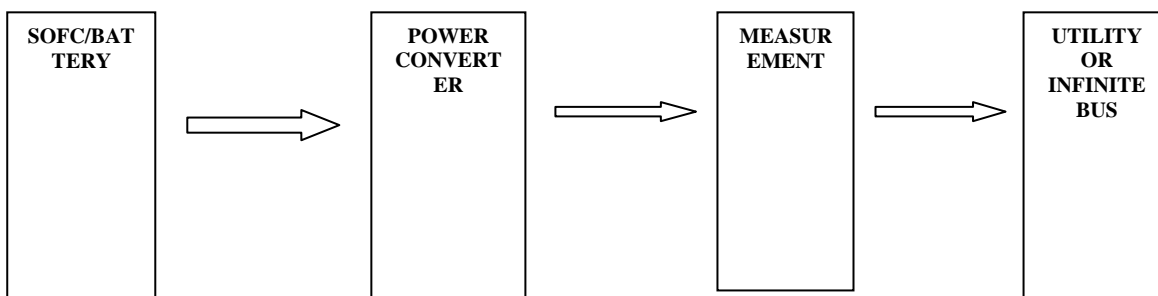

SOFC and energy battery are of growing interest for distributed and/or renewable resource generation and energy storage. Also they have interesting non-linear DAE models.

A. Modeling of SOFC

Fuel cells are a promising technology for producing electrical energy. The main issues that complicate the design of efficient and robust fuel cells are related to electrode heating and corrosion. However fuel cells are expected to play an important role in distributed generation.

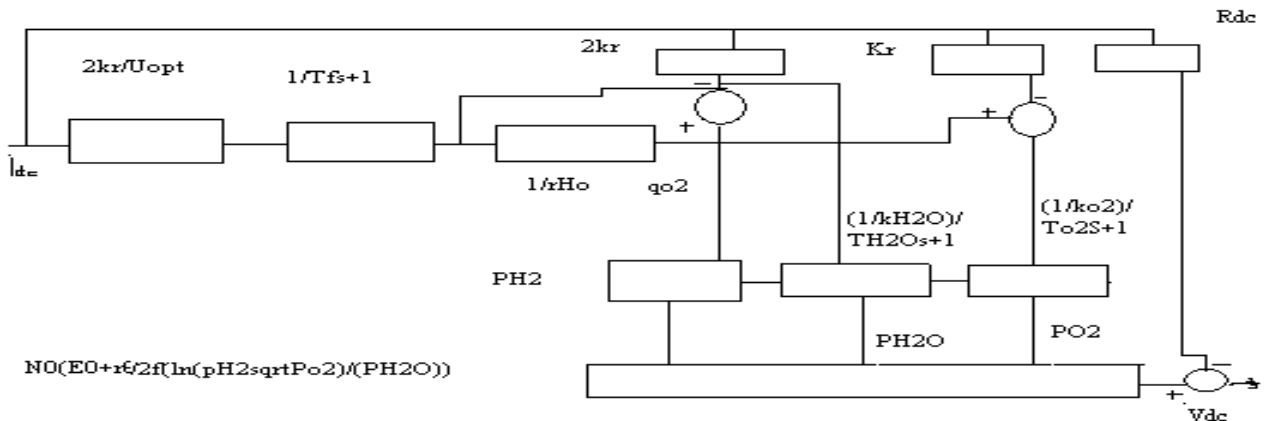

Fig 2 Solid Oxide fuel cell scheme:
Thermodynamic energy balance:

$$\dot{\theta} = \frac{1}{m_g C_p} (\theta_e - h_c A_c (\theta - \theta_a) - \sigma \epsilon A_r (\theta^4 - \theta_a^4))$$

Electrochemical reaction dynamics:
PH₂, PH₂O, PO₂, qH₂.

Fuel cell voltage:

$$-V_{dc} - R_{dc}(\theta)i_{dc} + \frac{N_0}{V_{dc}n} \left(E_0 + \frac{r\theta}{2f} \ln \left(\frac{PH_2}{PH_2O} \sqrt{\frac{PO_2}{PH_2O}} \right) \right)$$

Mole fractions: PH₂, PH₂O, PO₂, qH₂, qH₂O, qO₂--- H₂, H₂O, O₂, r=gas constant=8.314J/mol/K

F=faraday's constant=96487C/mol

K_r depends on the number of Electrons ne in the reaction, faraday's fonts and current rating I_{dc}, $n = \frac{S_n}{V_{dc}n}$, $K_r =$

$$k_r I_{dc} n = \frac{ne I_{dc} n}{4f}$$

Ohmic losses are modeled through R_{dc} are due to the resistance to the flow of ions in the electrolyte and resistance to the flow of electrons through the electrode material. R depends on θ.

$$R_{dc} = R_{dc}^a e^{\beta r \left(\frac{1}{\theta_a} - \frac{1}{\theta} \right)}$$

SOFC control:

In practical usage, SOFC is linked to ac networks through a shunt connected VSC device. AC voltage magnitude V_n is regulated by means of the VSC inverter modulating amplitude a_m.

$$a_m = (K_m (V^{ref} - V_h) - a_m) / T_m$$

Amplitude control has limiter set points.

Fig 3 Control of SOFC

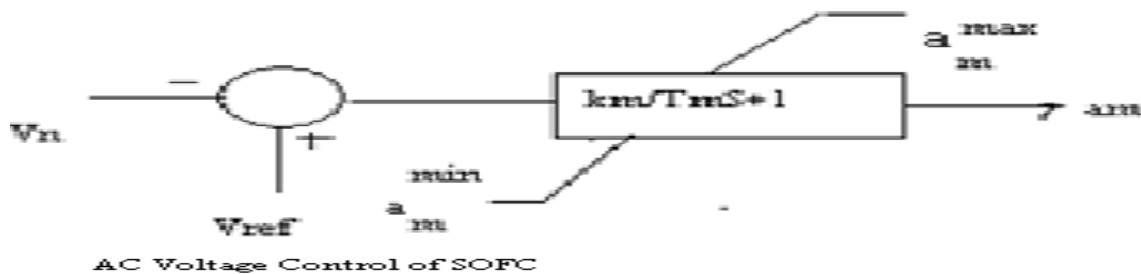

Fuel cell dc current set point i_{dc}^{ref} is defined based on power reference P^{ref}. i_{dc}^{ref} set point is limited by dynamic limits proportional to the hydrogen flow:



$$\frac{U_{min} qH_2}{2K_r} \leq i_{dc}^{ref} \leq \frac{U_{max} qH_2}{2K_r}$$

U_{min}^{max} are hydrogen gas flow limiter set point.

Current i_{dc} is regulated through the VSC firing angle α by means of PI controller.

Fig 4 Power control of SOFC

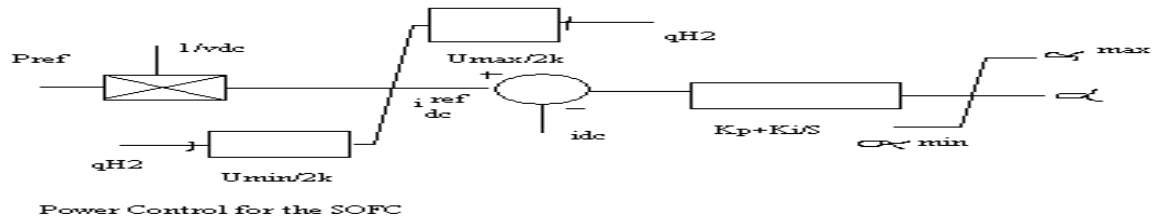

B. Battery As Power Source

Battery is a voltage source that depends on the generated current and on the state of charge (SOC) of the battery itself. There are several battery types, e.g. lead acid, Lithium ion, Lithium polymer, nickel cadmium, nickel- metal hydride, zinc etc.

Modeling of Battery:

Dynamic rechargeable battery model suggest

$$q_e = \frac{i_{dc}}{3600}, i_m = \frac{i_{dc} - i_m}{T_m}, 0 = v_{oc} - v_p(q_e, i_m) + v_e e^{\beta_e q_e} - R_i i_{dc} - v_{dc}$$

Where q_e is the per unit extracted capacity normalized with respect to the maximum battery capacity Q_n in Ah, i_m is the battery current i_{dc} passed through a low pass filter, the polarization volt $v_p(Q_e)$ depends on the sign of i_m , as follows:

$$v_p(q_e, i_m) = \begin{cases} \frac{R_p i_m + K_p q_e}{SOC} & \text{if } i_m > 0 (\text{discharge}) \\ \frac{R_p i_m}{q_e + 0.1} + \frac{K_p q_e}{SOC} & \text{if } i_m < 0 (\text{charge}) \end{cases}$$

$$SOC = \frac{Q_n - Q_e}{Q_n} = 1 - q_e$$

where q_e is the extracted capacity in Ah.

Apart from the SOC, another aspect for battery model is the parameter dependence on the temperature. The internal and polarization resistances are a function of the average battery temperature θ . Battery equivalent total internal resistance as a function of both θ and SOC. As a consequence of the internal resistance is that, during the charge and discharge processes, the battery generates heat proportionally to the energy transit in the time interval. To avoid over-heating, battery has to be cooled down.

$$\dot{\theta} = \frac{1}{c_p m_g} \left(S_n v_{dc} i_{dc} \left(1 - \eta_v + \frac{\epsilon_d}{V_{dc} \eta V_{oc}} \right) - h_c A_c (\theta - \theta_a) - \sigma_\epsilon A_r (\theta^4 - \theta_a^4) \right)$$

Where $\sigma = 5.670 \times 10^{-8} \text{ w/m}^2/\text{k}^4$ is the Stefan's Boltzmann's constant.

C. Voltage source converter model

It is a simplified dynamic model. VSC can be modeled taking in to account only power balance and simplified control equation.

If the power flow is from dc side to ac one, power balance is

$$0 = V_{dc} i_{dc} - P_{ac} - P_{loss}(i_{dc} v_{dc})$$

P_{loss} is commutation and conduction loss of switch diodes and capacitor.

Simplified control equations do not explicitly include the firing angle α and the modulating amplitude is a_m , but only considers input and output variables. Hence to regulate active and reactive powers on the ac side, the control differential equations can be written as

$$P_{ac} = (P^{ref} - P_{ac})T_p, q_{ac} = (q^{ref} - q_{ac})T_q$$



Fig 5 Converter Model

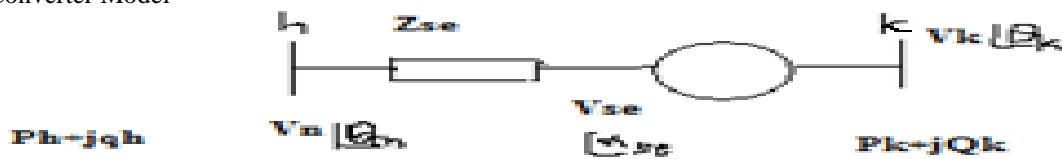

D. Modeling of Mixed Load as Utility

Utility has two main parameters voltage and frequency. Also since utility is modeled as infinite bus which is represented as constant voltage bus with $V_t=1pu$. Thus modeling of utility (infinite bus) can be as voltage dependent and also as frequency dependent either as dependable or as independent source.

Figure A shows combination of voltage and frequency dependent representation while figure B shows voltage and frequency dependent inputs to a constant (v,f) representation as independent representation. Output variables are vector V_h and X_θ .

Fig 6 Load Model

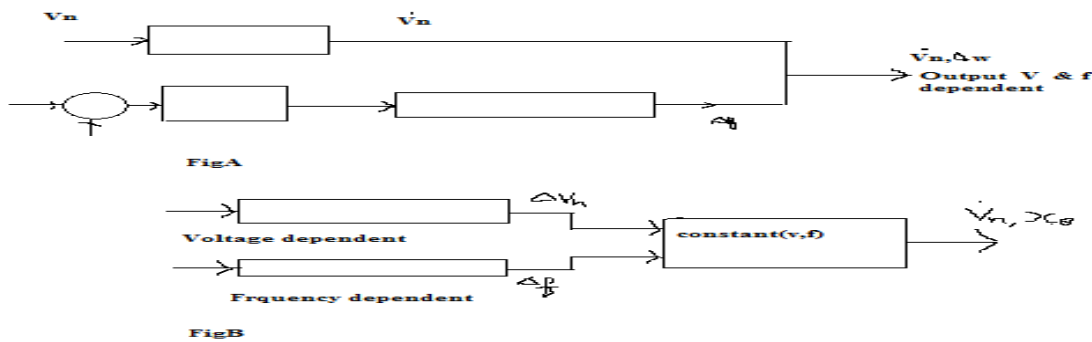

E. Block diagram of soft application

Fig 7 SOFC application

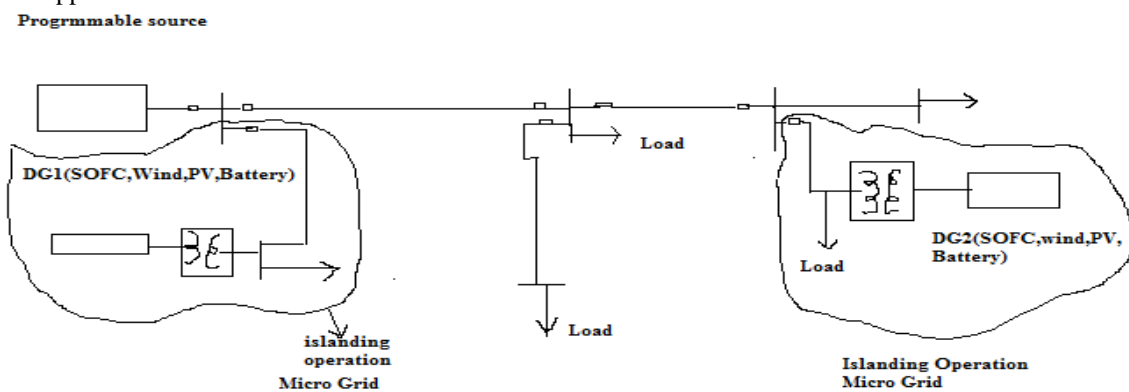

SOFC as power plant to operate in micro grid in islanding condition, operated through circuit breaker. So SOFC in isolated stand alone operation.(variable voltage and frequency)

SOFC as distributed generation for grid operation in stand alone operation. (Concept of Micro Grid).

III. SIMULATION CIRCUIT

A simulation circuit for SOFC interfacing with utility modeled as infinite bus is developed and simulated in Mat lab 7 environment. A comparative is established with battery as power source device interfacing with utility. Model of a solid oxide fuel cell (SOFC) which can be utilized in Sim Power System.

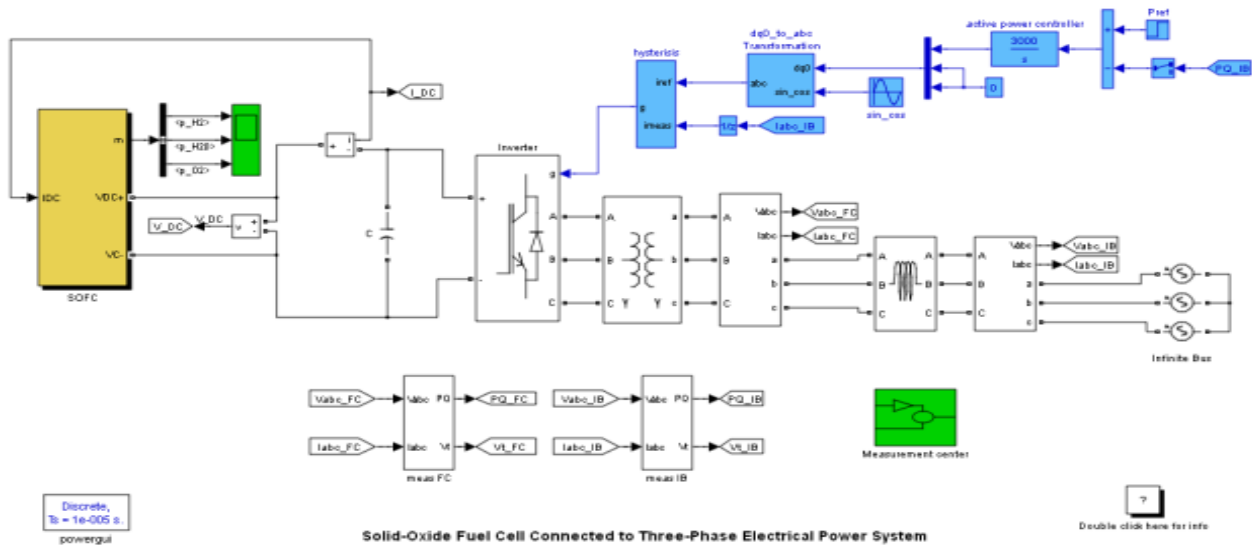

Fig 8 SOFC Based Simulation Circuit

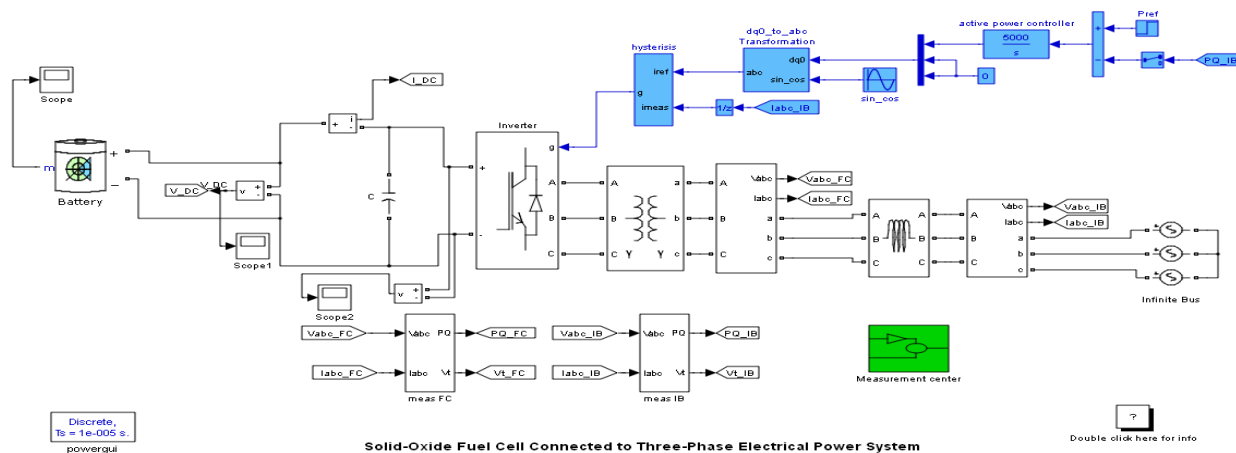

Fig 9 Battery Based Simulation Circuit

F. Circuit Description:

The system consists of a SOFC which is connected to a 3φ Infinite Bus through an IGBT inverter. The inverter uses hysteresis switching and controls active power by manipulation of direct axis current while holding reactive power at 0Var. The measurement blocks are rated at 50KW. Therefore, an active power reference of 1pu=50Kw.

Simulation:

At t=0s, an active power reference (P_{ref}) of 0.3pu is commanded. Observe that the reference is captured within 0.2s.

At t=0.4s, P_{ref} = 1pu is commanded. Again the ref is captured within 0.2s.

Observations of the H₂, H₂O and O₂ pressure shows that the fuel cell does not reach a new equilibrium for the simulation of duration 1sec. Extended simulation periods are required to observe the dynamics of chemical reaction.



Assumptions:

- 1) Fuel cell gases are ideal.
- 2) Only one pressure is defined in the interior of the electrodes.
- 3) The fuel cell temperature is invariant.
- 4) Nernst's equation applies.

G. Block Parameters of Simulation Circuit:

1) SOFC

Absolute Temp: 1273K, Initial Current: 100A, Faraday's Constant(C/Kmol): $96.487e^6$
Universal Gas Constant(J/KmolK): 8314,Ideal standard potential(V):1.18,No of cells in series:450/300
Max, Min & optimal fuel utilization:[0.9,0.8,0.85],
Valve molar const for H₂, H₂O & O₂(Kmol)/(s atm):[$8.43e^{-4}$, $2.81e^{-4}$, $2.52e^{-3}$]
Response Time for H₂,H₂O & O₂ flow(s):[26.1 78.3 2.91], Ohmic loss per cell (ohms): $3.2813e^{-004}$
Electrical response time(s):0.8,Fuel processor response time(s):5,Ratio of H₂/O₂:1.145

2) BATTERY

a) Nickelmetalhydride ,Nominal voltage(v): 400,Rated capacity(Ah):100,Initial State of Charge:100%
Discharge current[i₁ i₂..]:[1.5 3],Units: Amhr,Full charge volt(%): 108,
Nominal discharge current[% of rated current]:5,Internal resistance (ohms):0.02
Exp Zone(volt%,capacity(% of rated capacity):[102.5 0.08]

b) Nickelcadmium

Nominal voltage(v): 400, Rated capacity(Ah):100,Initial State of Charge:100%,Discharge current[i₁ i₂..]:[1.5 3]
Units: Amhr

c)No User Defined:

Nominal voltage(v): 400,Rated capacity(Ah):100,Initial State of Charge:100%,Full charge volt(%): 108
Nominal discharge current[% of rated current]:5,Internal resistance (ohms):0.02,Exp Zone(volt%,capacity(% of rated capacity):[102.5 0.08],Discharge current[i₁ i₂..]:[1.5 3],Units: Amhr

d) Lithium Ion/Lead Acid

Nominal voltage(v): 400,Rated capacity(Ah):100,Initial State of Charge:100%,
Discharge current[i₁ i₂..]:[6.5 13 32.5],Units: Amhr

3) INVERTER

No of bridge arms:3, Snubber resistance R_s(ohms): $1e^5$,Power Eln device: IGBT/Diodes,R_{on} (ohms): $1e^{-3}$
Forward voltages [device V_f(v), Diodes V_{fd}(v):[0 0],[T_f(s), T_t(s)]: $1e^{-6}$, $2e^{-6}$,Measurements: None

4)Transformer

Configuration : WDG1:star,WDG2:star

Parameters:

Units: pu

Nominal Power and frequency[P_n(va),f_n(Hz)]:[$1e^6$ 60]

Wdg1 parameter:[v1 ph-ph(Vrms),R1(pu),L1(pu)]:[200, $1e^{-4}$,0.04]

Wdg2 parameter:[v1 ph-ph(Vrms),R1(pu),L1(pu)]:[440, $1e^{-4}$,0.04]

Magnetization resistance R_m (pu):500,Magnetization inductance L_m (pu):500,Voltage: ph-ph,

Current: Yes

Three Phase V-I Measurement:

Three phase series RLC branch:,Branch type:L,Inductance L(H): $1e^{-3}$,Measurements: None

Three phase VI measurement:,Voltage: ph-ph,Current: yes

AC voltage source 2

Ideal sinusoidal AC voltage source,Peak amplitude(v): $440*\sqrt{2}/\sqrt{3}$,Phase(degree):0⁰

Frequency(Hz):60,Sample Time:0,Measurements: None

Measurement F_c

Generator data:[$50e^3/0.8$ 440 60],Voltage (pu): Three phase RMS,P and Q: Three phase RMS

Measurement IB

Generator data: [$50e^3/0.8$ 440 60],Voltage (pu): Three phase RMS,P and Q: Three phase RMS

Hysteresis:

a) Relay

Sw on point: eps,Sw off point: eps,Output when On:1,Output when Off:0,Enable zero crossing detection:

Sample Time (-1 for inherited): -1



Block Parameter P_{ref}

Step time:0.4,Initial value:0.3,Final value:1,Sample time:0

Active Power Contoller

Num coefficient – 3000/5000,Deno coefficient – [1 0],Absolute tolerance: Auto

SOURCE BLOCK PARAMETERS

SIN & UNIT DELAY,SIN TYPE: Time based,Time (t): use simulation time,Amps: 1,Bias:0

Frequency:2* P_1 *60,Phase(rad) [0 $P_1/2$],Sample time:0,Dq0 to abc transformation,Unit Delay 1

Initial condition:0,Sample time(-1 for inherited): T_s

IV. RESULTS AND DISCUSSION

Waveforms of Simulation:

A) SOFC 3000hrs

Fig 10 V_{dc} and I_{dc}

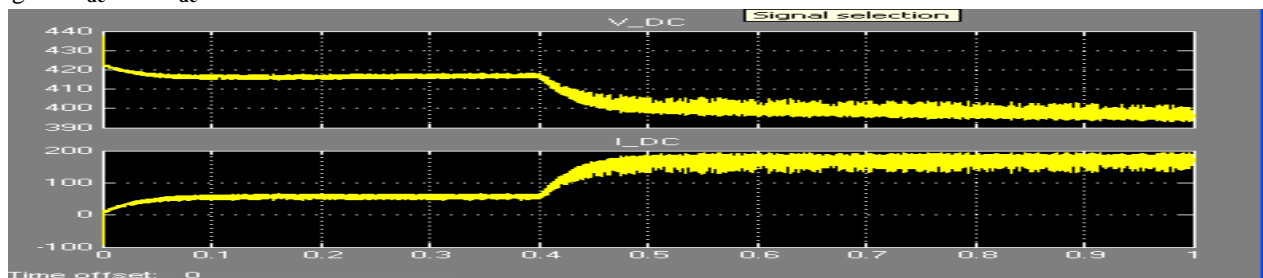

Fig 11 PQ FC and PQ IB

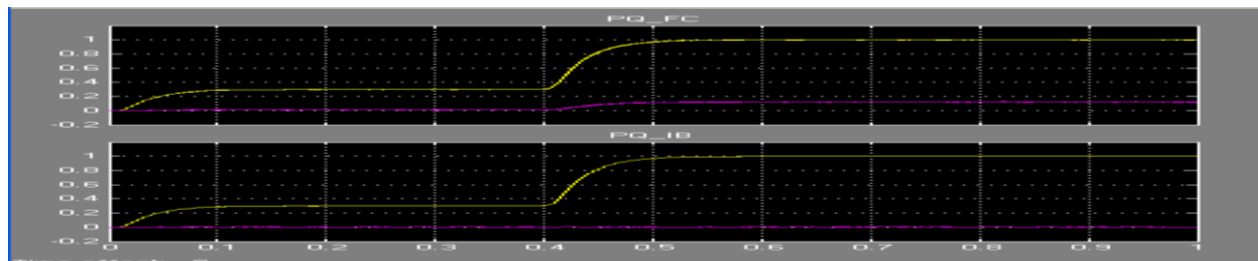

Fig 12 V_t FC and V_t IB

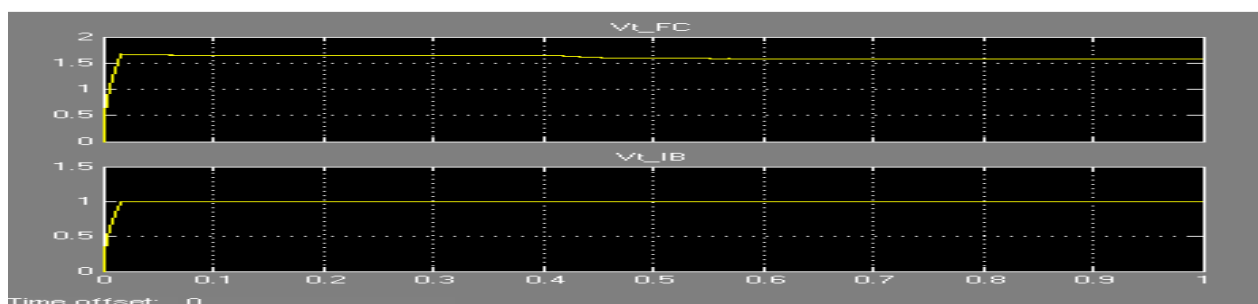



Fig 13 V_{abc} FC and V_{abc} IB, I_{abc} IB

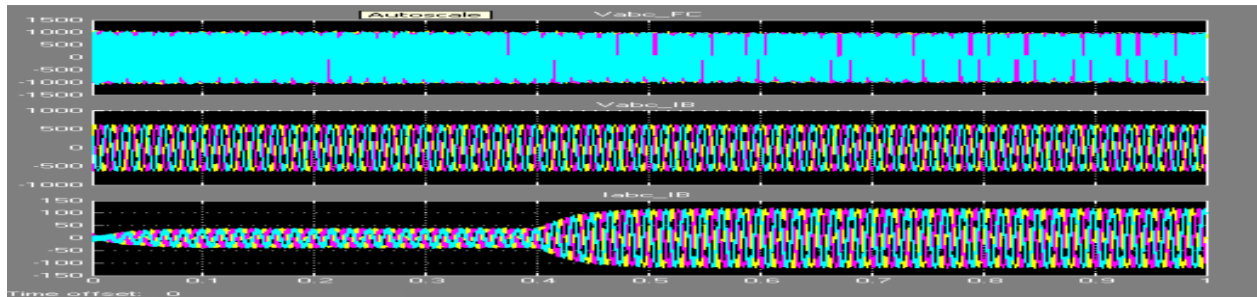
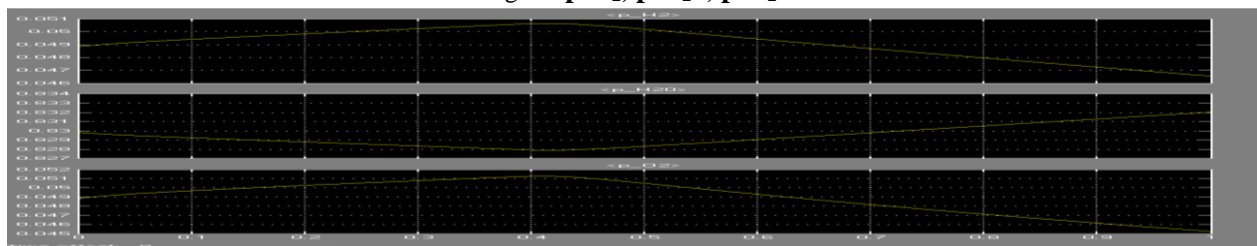

Fig 14 p_{H_2} , p_{H_2O} , p_{O_2}



B) SOFC 5000hrs

Fig 15 V_{dc} and I_{dc}

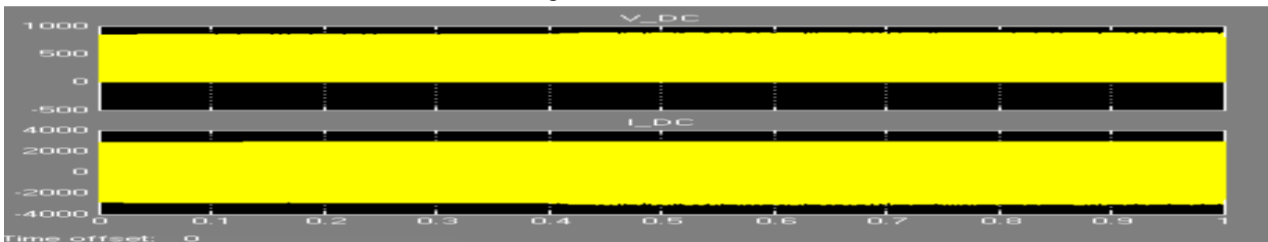

Fig 16 PQ FC and PQ IB

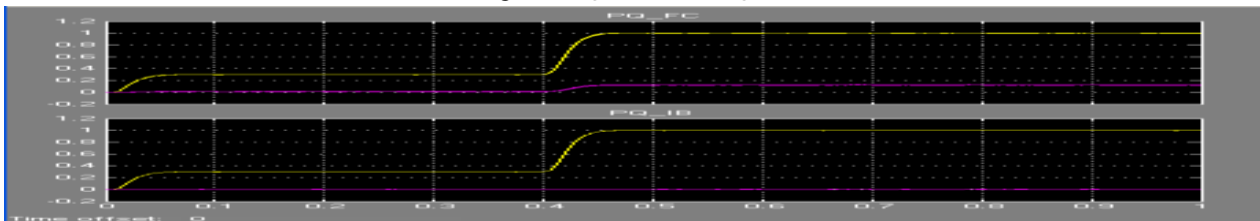

Fig 17 V_t FC and V_t IB

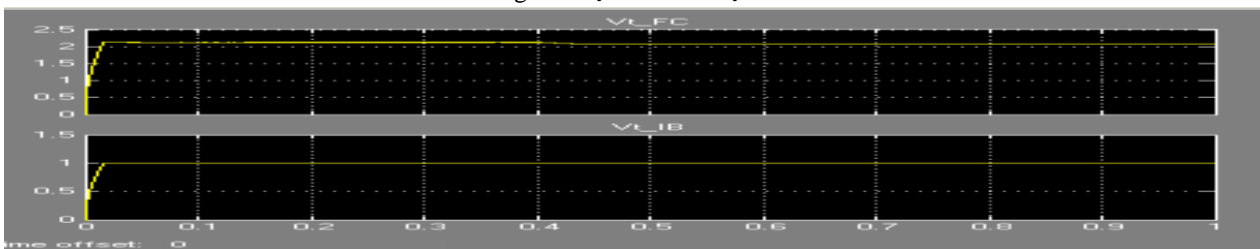



Fig 18 V_{abc} FC and V_{abc} IB, I_{abc} IB

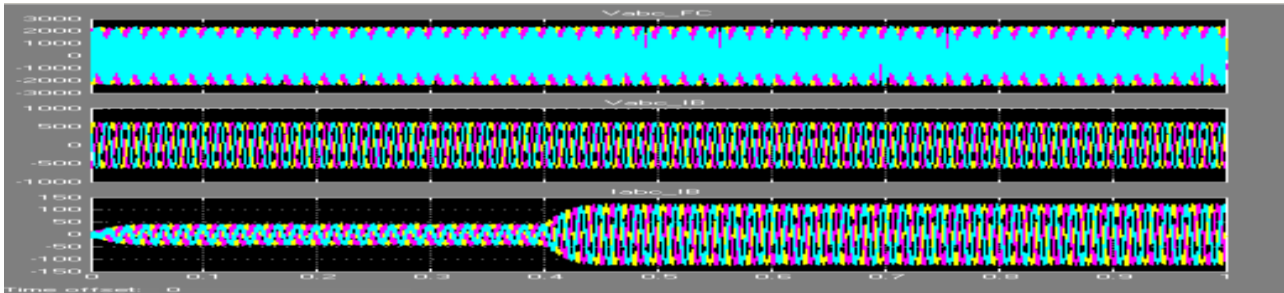
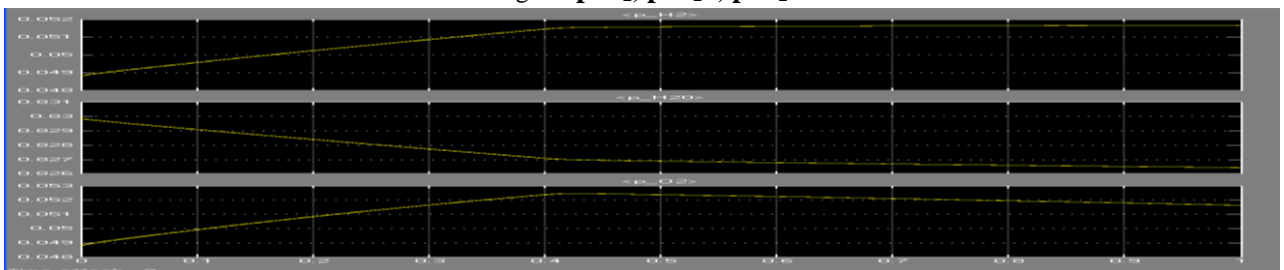

Fig 19 p_{H_2} , p_{H_2O} , p_{O_2}



C) SOFC 5000hrs 300cell

Fig 20 V_{dc} and I_{dc}

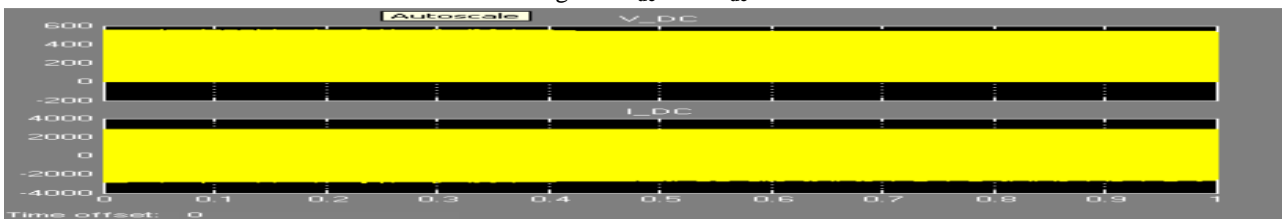

Fig 21 PQ FC and PQ IB

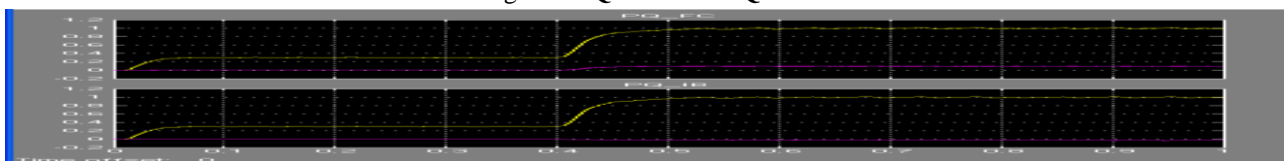

Fig 22 V_t FC and V_t IB

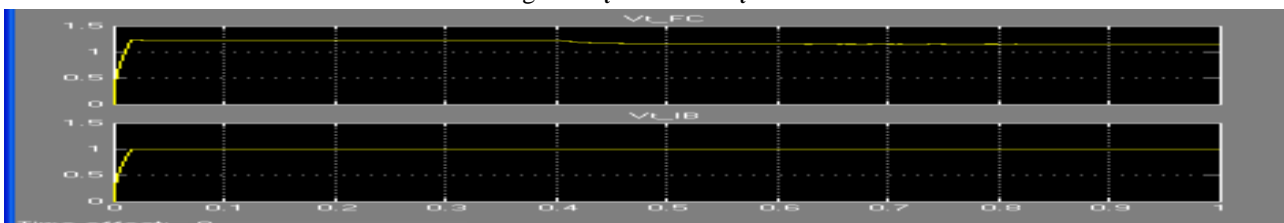



Fig 23 V_{abc} FC and V_{abc} IB, I_{abc} IB

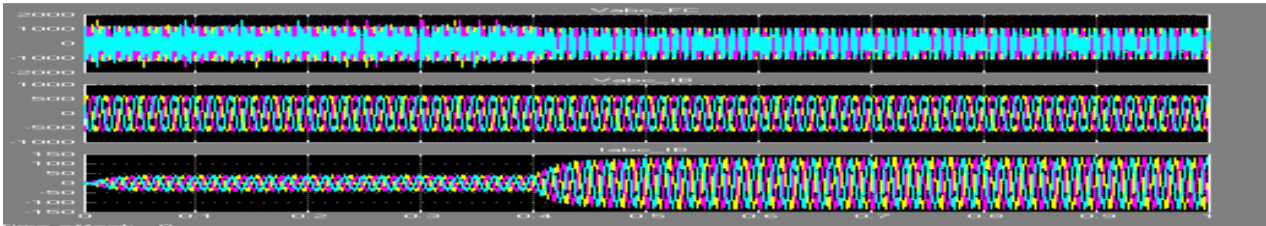
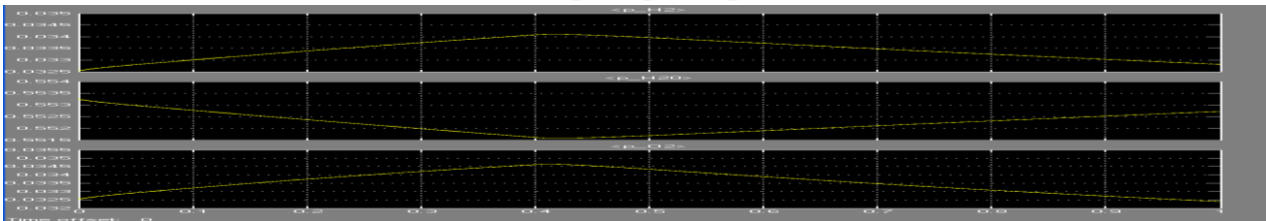

Fig 24 p_{H_2} , p_{H_2O} , p_{O_2}



D) BATTERY WAVEFORMS

i) NickelMetalHydride

Fig 25 V_{dc} and I_{dc}

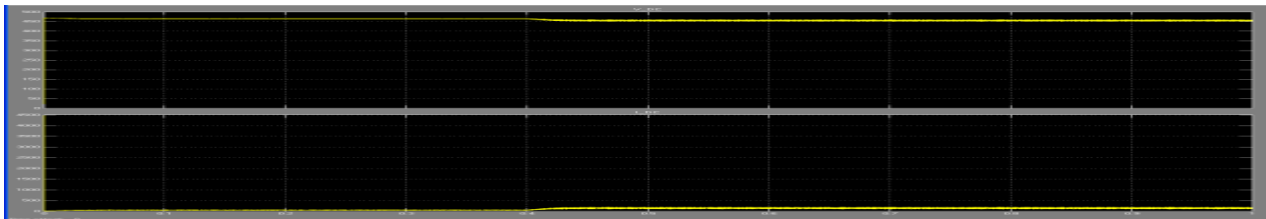

Fig 26 PQ FC and PQ IB

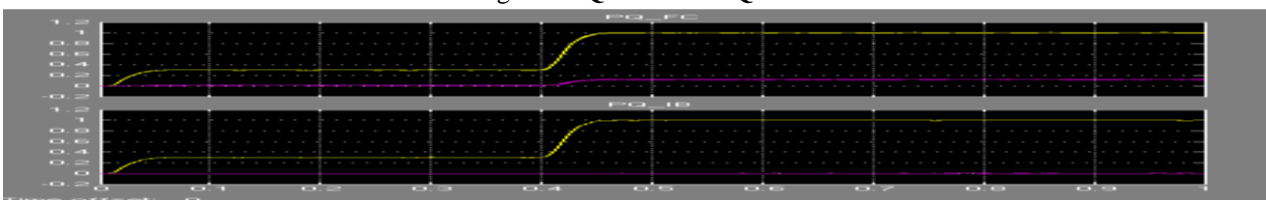

Fig 27 V_t FC and V_t IB

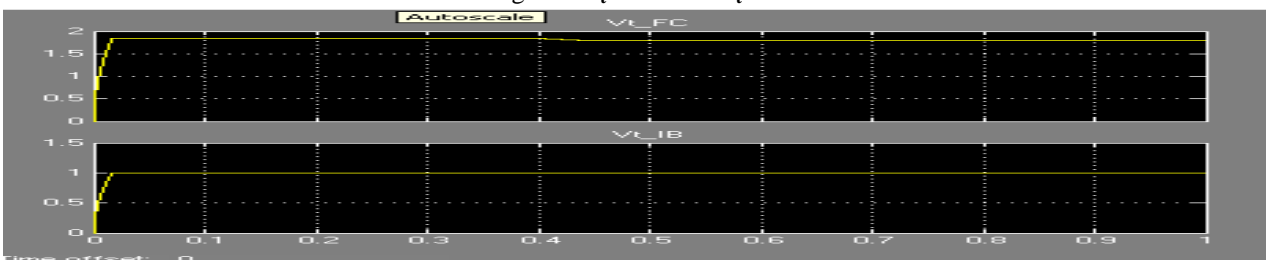



Fig 28 V_{abc} FC and V_{abc} IB, I_{abc} IB

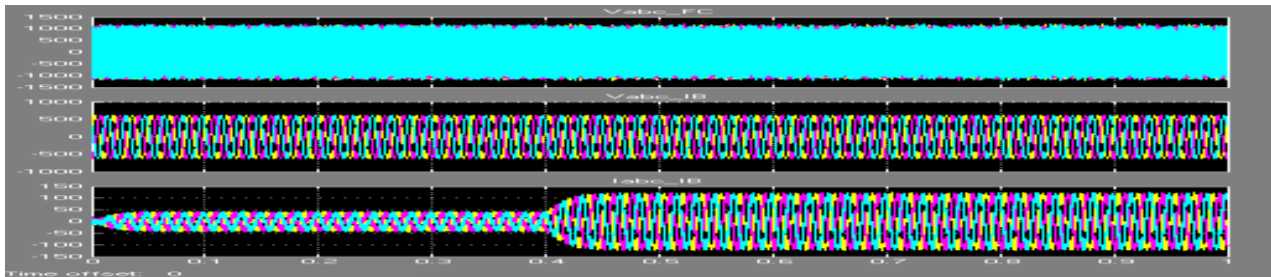
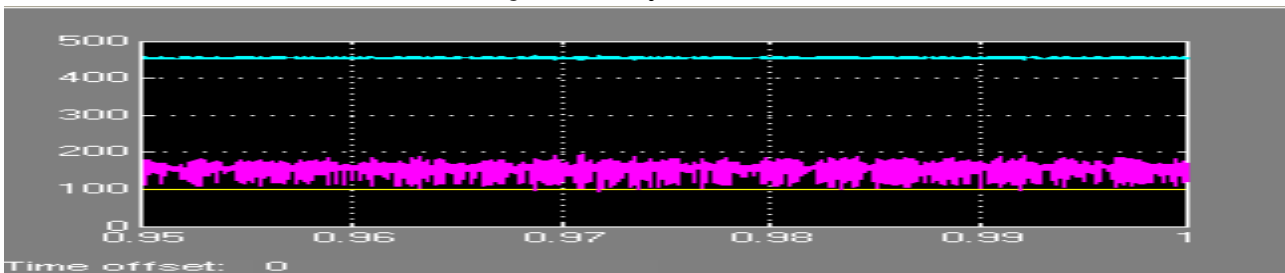

Fig 29 Battery waveform



ii) No User defined

Fig 30 V_{dc} and I_{dc}

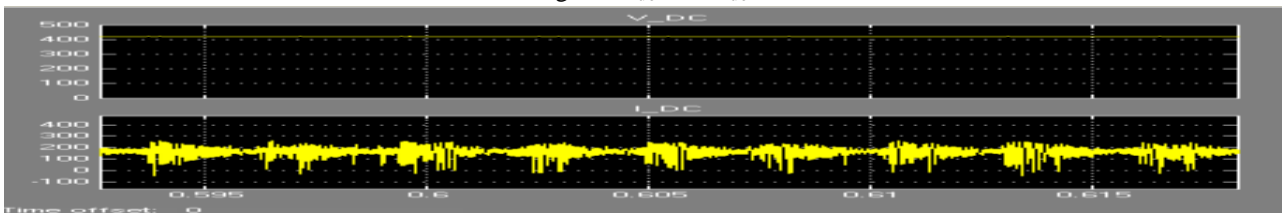

Fig 31 PQ FC and PQ IB

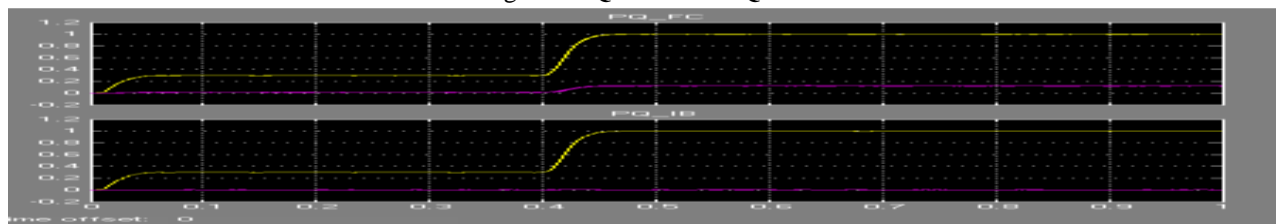

Fig 32 V_t FC and V_t IB

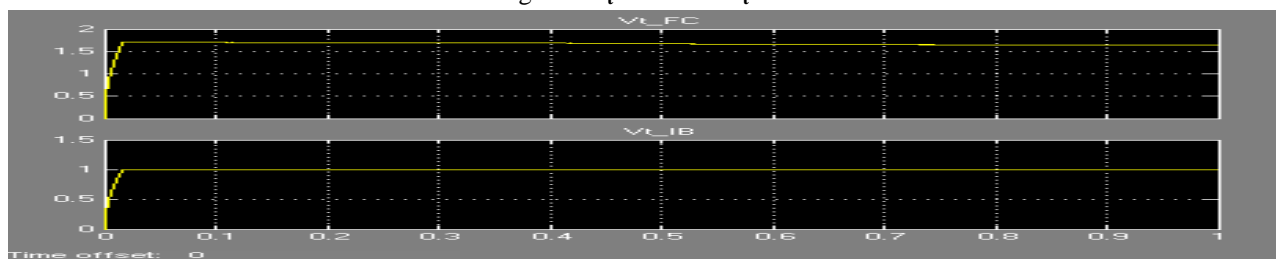



Fig 33 V_{abc} FC and V_{abc} IB, I_{abc} IB

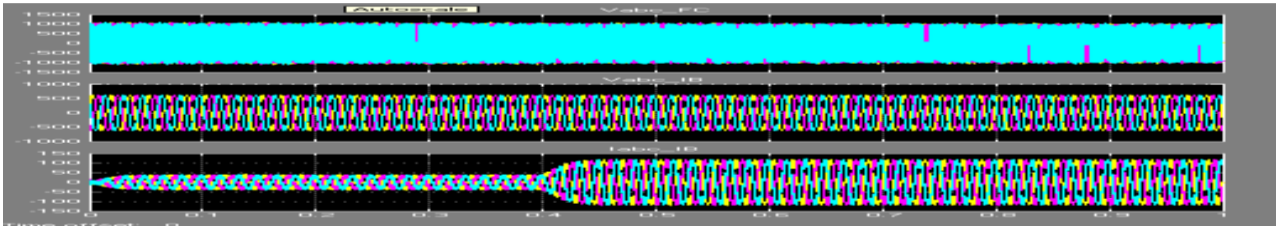
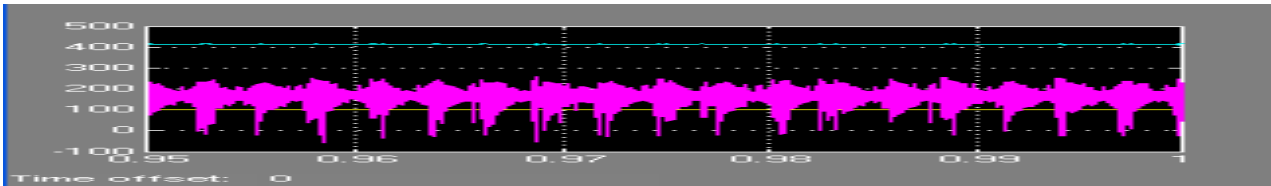

Fig 34 Battery waveform



iii) Nickel cadmium

Fig 35 V_{dc} and I_{dc}

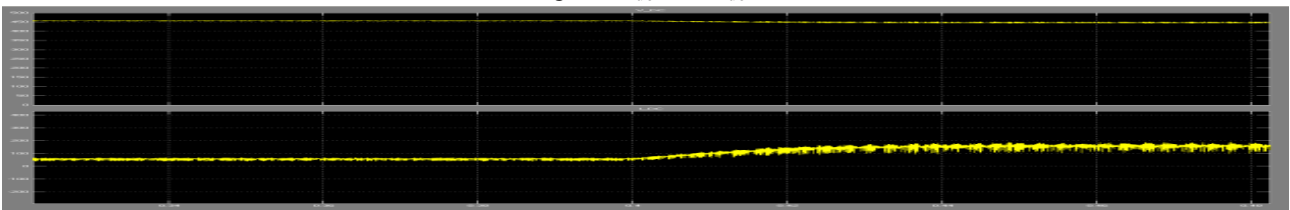

Fig 36 PQ FC and PQ IB

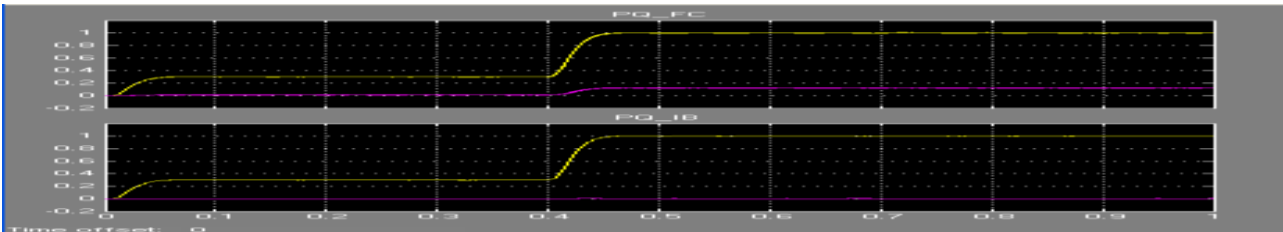

Fig 37 V_t FC and V_t IB

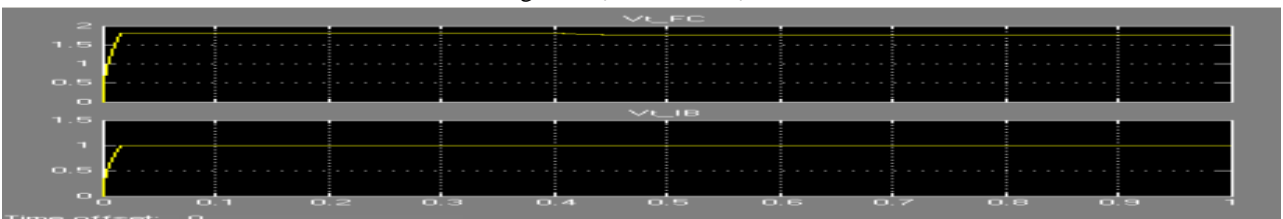

Fig 38 V_{abc} FC and V_{abc} IB, I_{abc} IB

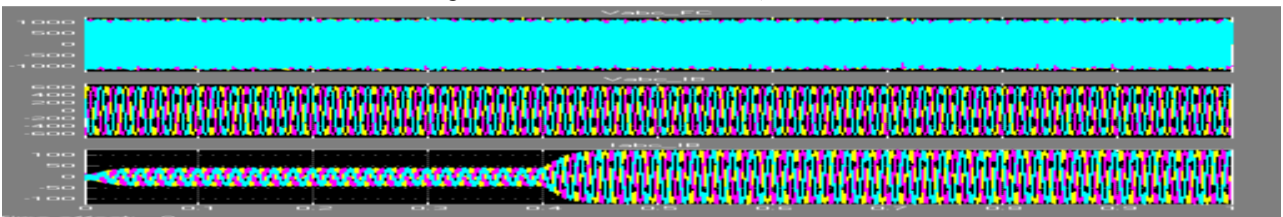
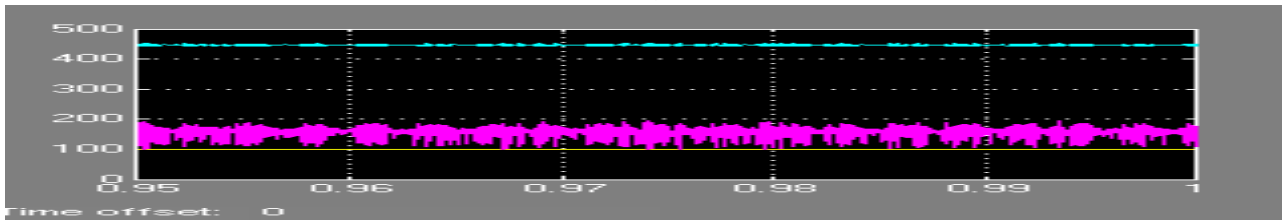



Fig 39 Battery waveform



iv) Leadacid

Fig 40 V_{dc} and I_{dc}

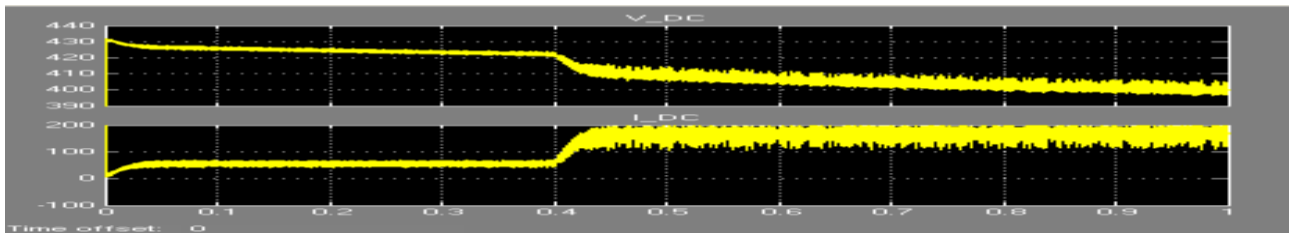

Fig 41 PQ FC and PQ IB

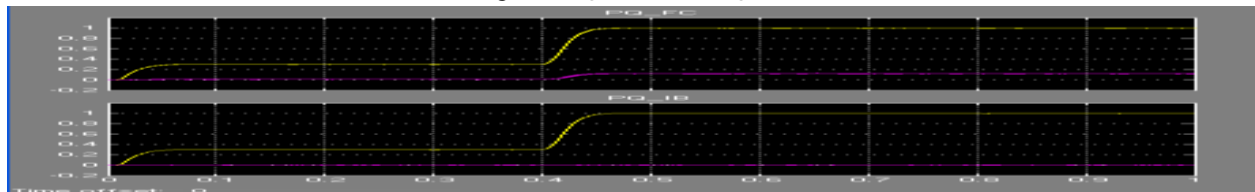

Fig 42 V_t FC and V_t IB

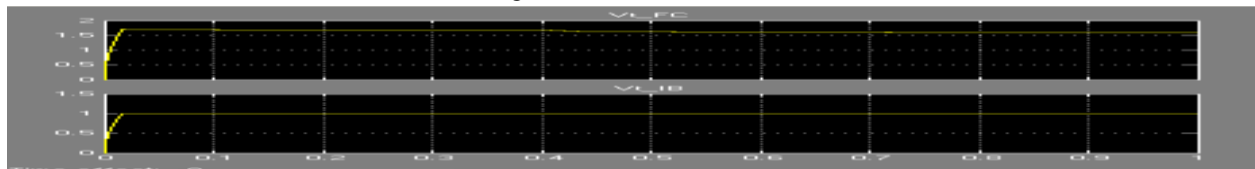

Fig 43 V_{abc} FC and V_{abc} IB, I_{abc} IB

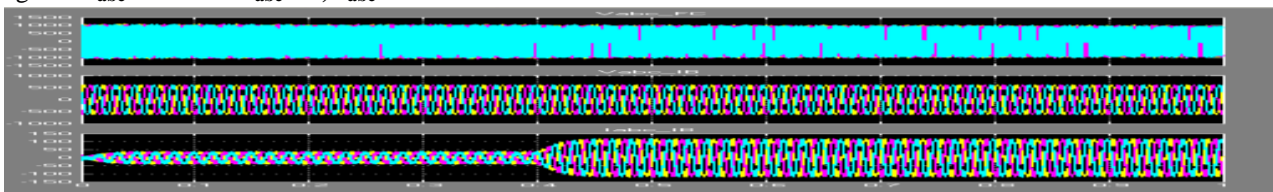
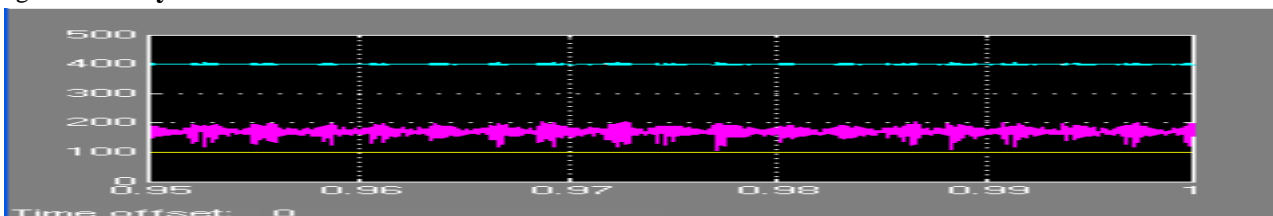

Fig 44 Battery waveform



v) LithiumIon



Fig 45 V_{dc} and I_{dc}

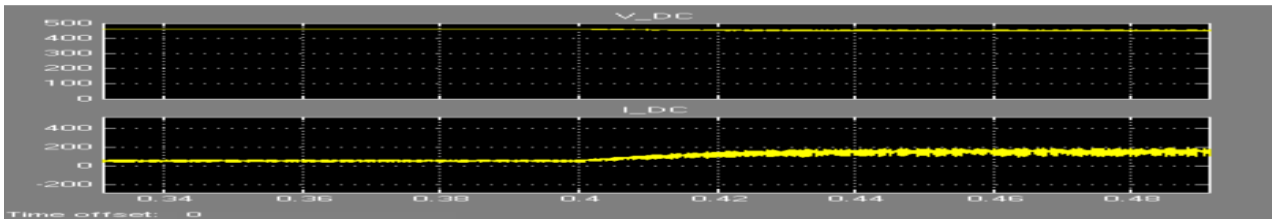

Fig 46 PQ FC and PQ IB

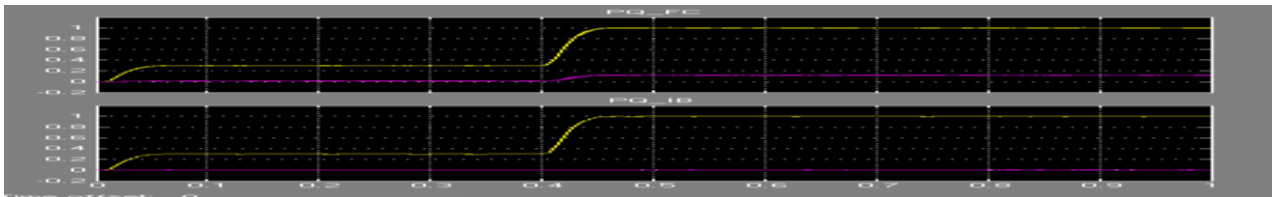

Fig 47 V_t FC and V_t IB

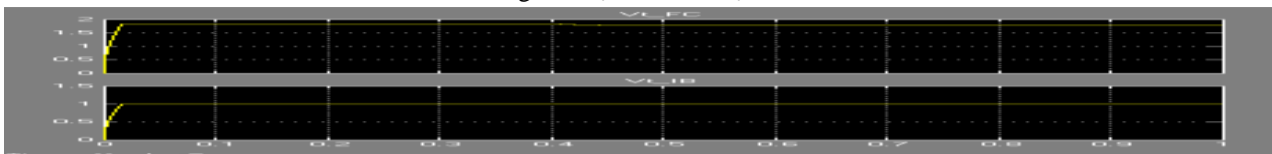

Fig 48 V_{abc} FC and V_{abc} IB, I_{abc} IB

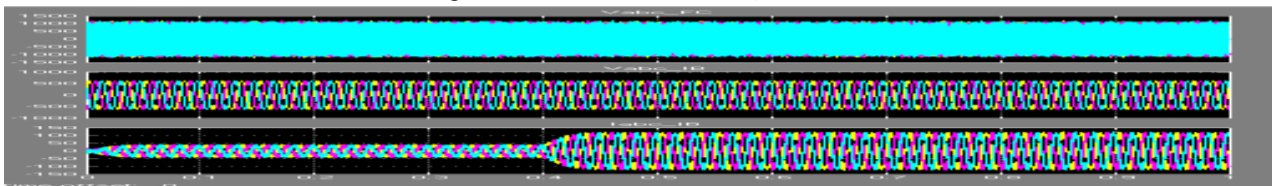
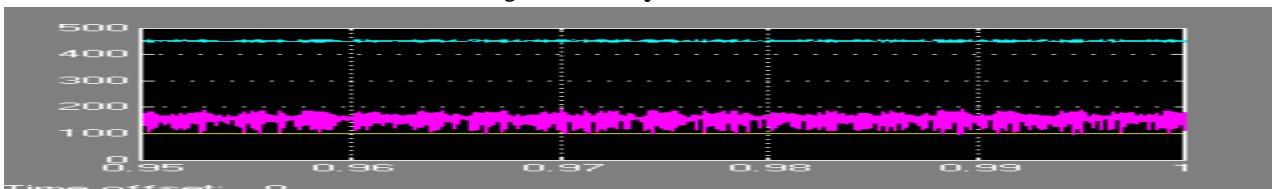

Fig 49 Battery waveform



COMPARISON OF SOFC AND BATTERY PERFORMANCE

Sr No	SOFC 3000 hrs	SOFC 5000hrs	Ni Mtl Hydrde	No Usr defined	Nicad	Ld acid	Li Ion
V_{dc}	420	850	465	428	460	425	460
I_{dc}	200	2500	200	200	200	200	200
P	1	1	1	1	1	1	1
Q FC	0.12	0.12	0.12	0.12	0.12	0.12	0.12
PQ IB	1×10^{-3}	1×10^{-3}	1×10^{-3}	1×10^{-3}	1×10^{-3}	1×10^{-3}	1×10^{-3}
V_t FC	1.6	2.08	1.8	1.67	1.8	1.8	1.6
V_t IB	1	1	1	1	1	1	1
V_{abc} FC	1000	2200	1000	1000	1000	1000	1000
V_{abc} IB	500	600	600	600	600	600	600
I_{abc} IB	120	120	120	120	120	120	120
	50	50	50	50	50	50	50



TABLE NO 1

Analysis of results:

- ❖ All battery types are identical in performance with respect to V_{dc} , I_{dc} , PQ, V_{abc} , & I_{abc} .
- ❖ SOFC gives similar response like battery with respect to V_{dc} , I_{dc} , PQ, V_{abc} , & I_{abc} .
- ❖ Due to high operating temperature conditions compared to battery, SOFC does not require catalyst addition to reduce cost.
- ❖ SOFC can be used for isolated consumers or isolated installation using DC/AC converter technology
- ❖ SOFC application can be utilized for micro grid operation during islanding conditions.
- ❖ SOFC can be also used as distributed generation source.
- ❖ SOFC integration with utility is a case of power system operation.
- ❖ DC/AC inverter technology can give variable voltages also at utility.
- ❖ SOFC has achieved durability of the system for 3000hrs and 5000hrs.
- ❖ SOFC for 500hrs using hysteresis band has better characteristic compared to 3000hrs.
- ❖ All battery waveforms are identical with respect to V_{dc} for 5000hrs.
- ❖ SOFC waveform for 5000hrs is not in total comparison with V_{dc} and I_{dc} while battery & SOFC 3000hrs are in total comparison with respect to V_{dc} and I_{dc} .
- ❖ V_1 at utility remains at 1pu in all cases although Fuel cells (battery) voltages are different and up to 1.8 pu.
- ❖ Active power in each case is 1pu while reactive power ranges between 1×10^{-3} to 2×10^{-3} pu and is not zero.
- ❖ Fuel cell voltages are greater than 1pu so V_{abc} FC are approximately 1000V, for battery and SOFC while V_{abc} IB (utility) remains at 500V and 440V approximately in each case.
- ❖ I_{abc} IB (utility) for each case remains at 120A constant.
- ❖ SOFC's H_2O , H_2 and O_2 gases constituents are also in tolerable zone and variations are marginal for 3000hrs to 5000hrs.
- ❖ Battery waveforms for V_{dc} , I_{dc} and SOC are identical for all types of battery.
- ❖

V. CONCLUSION

Interfacing of SOFC with utility (infinite bus) is obtained with simulation in MAT LAB 7. SOFC is a power source supplying utility for 3000hrs autonomy. SOFC has replaced battery technology in fuel cell market approach. Interface between SOFC and utility was based on power electronics DC/AC conversion technology. Simulation results V_{dc} , I_{dc} , PQ, V_{abc} , & I_{abc} suggest application of SOFC interface with utility for isolated consumer or isolated installation. SOFC interface with infinite bus can be distributed generation application and also be utilized for micro grid operation under islanding condition. Thus proposed work has established and developed SOFC interface with utility for application as power plant, distributed generation and micro grid islanding operation technology.

ACKNOWLEDGEMENT

The facility of simulation based Mat Lab 7 software at Electrical Engineering department of Faculty of Technology and engineering has made this work developed for technological application oriented.

REFERENCES

- [1] Dr.Fredrico Milano,"Power System Modeling and Scripting." published by Springer-Verlog London Limited 2010.
- [2] Dr.J Datta,"Fuel cell technology: A challenge for pristine power."Technorama, (publication of the institution of Engineers (India) march 2011, Vol 60, pg 5-9.
- [3] Hatziadoniu, C J, Lobo, A A, Pourboghlat, F, Daneshdoost, M,"A simplified dynamic model of grid connected fuel cell generators,IEEE transactions on power systems 17(2), 467-473(2002).
- [4] Knyazkin, V, Soder, L, Canizares, C,"Control challenges of Fuel cell driven distributed generation,"Proceedings of the IEEE PES general meeting, Toronto(July 2003)
- [5] Padulles, J, Ault, Gw, McDonald, J R," An integrated SOFC plant dynamic model for power systems simulation." International journal of power sources 86, 495-500(2000).
- [6] Sedghisigarchi, K,Feliachi, A," Dynamic and transient analysis of power distribution systems with Fuel cells, PartI: Fuel cell dynamic model, IEEE Transactions on power systems 19(2), 423-428. (2004).
- [7] Zhu, Y, Tomsovic, K" Development of models for analyzing the load following performance of micro turbines and fuel cells. Electric power systems research 62(1),1-11(2002).



[8] Tremblay, O, Dessaint, L A, Dekkiche, A I, "A generic battery model for the dynamic simulation of hybrid electric vehicles." Proceedings of the IEEE vehicle power and propulsion conference, Arlington, TX, USA, September 2007, pg no 284-289 (2007).

BIOGRAPHY

Anuradha Deshpande : She has obtained M.E (Electrical) in the year 1996 from Faculty of Technology & Engineering, MAHARAJA SAYAJIRAO UNIVERSITY OF BARODA, Vadodara, Gujarat, India. At present she has submitted her PhD thesis and is working as Associate Professor.

She has industrial professional experience of working as sales engineer & design engineer in companies like ECG(I)L, Ahmedabad, Jyoti Switchgears Ltd, Mogar, Jyoti Ltd, Vadodara. At present she is working as associate Professor in Electrical Engineering department of Faculty of Technology & Engineering, MAHARAJA SAYAJIRAO UNIVERSITY OF BARODA. She has many papers published in National and International conferences, as well as in some of the reputed journals of national and international repute.

Her areas of interest are renewable energy sources, FACT application, Evolutionary Programming, etc.